

Kaikoura District



**KAIKOURA
DISTRICT COUNCIL**

Drainage Bylaw

2020

Table of Contents

TABLE OF CONTENTS	1
INTRODUCTION	3
1.1 INTRODUCTION	3
1.1.1 COMMENCEMENT:	3
1.2 DEFINITIONS	3
1.3 ACCEPTANCE OF DISCHARGE	6
1.4 APPROVAL TO CONNECT	7
1.5 CONTINUITY OF DISCHARGE	7
1.6 PREMISES	7
1.7 DISCONNECTION	8
1.8 PUBLIC DRAINAGE SYSTEM	9
1.9 STORAGE OF HAZARDOUS MATERIALS	10
1.10 BREACHES AND REMEDIES	10
POLICY FOR THE DISCHARGE AND ACCEPTANCE OF WASTEWATER	11
2.1 INTRODUCTION	11
2.2 DOMESTIC WASTEWATER	12
2.3 ACCEPTANCE AND DURATION	12
2.4 APPLICATION TO CONNECT	13
2.5 POINT OF DISCHARGE	13
FIGURE 2.1 - POINT OF DISCHARGE LOCATION	15
2.6 LEVEL OF SERVICE	23
2.7 LIABILITY	23
2.8 EMERGENCY	24
2.9 MAINTENANCE AND REPAIR	24
2.10 BLOCKAGES	24
2.11 TREES	25
2.12 WORKING AROUND BURIED SERVICES	25
2.13 CUSTOMER'S DRAINAGE SYSTEM	26
2.14 PAYMENT	28
2.15 BREACHES AND REMEDIES	28
SCHEDULE A	29
MEMORANDUM OF ENCUMBRANCE FOR SECURING A SUM OF MONEY	30
SCHEDULE B	31

DEED OF COVENANT	31
<u>SCHEDULE C</u>	<u>33</u>
APPLICATION FORM FOR DOMESTIC WASTEWATER SERVICE CONNECTION	33
DIAGRAM FOR CONNECTION LOCATION	34
<u>SCHEDULE D</u>	<u>35</u>
PAYMENT ITEMS AND TERMS - EXAMPLE LIST	35

DRAFT

INTRODUCTION

1.1 Introduction

This bylaw is for drainage from both domestic and trade premises to a system operated by the Kaikoura District Council. The quality and quantity limits that separate domestic wastewater from trade waste are to be found in "New Zealand Standard Model Bylaws Chapter 23 (Int) Trade Waste". The Kaikoura District Council hereby resolve by way of special order to make the following Bylaw pursuant to the Local Government Act 1974 and all other powers and authority enabling it to make bylaws.

1.1.1 Commencement:

The Bylaw shall come into force on ?? November 2020.

1.2 Definitions

For the purposes of this bylaw the following definitions shall apply:

ACCEPTABLE DISCHARGE means a wastewater with physical and chemical characteristics which comply with the requirements of the Kaikoura District Council as scheduled in "New Zealand Standard Model Bylaws Chapter 23 (Int) Trade Waste".or by an officer of the Kaikoura District Council authorized for that purpose.

BURIED SERVICES means all public sewers, rising mains, stormwater drains and other underground utilities under the responsibility of the Kaikoura District Council.

CERTIFICATE OF TITLE means a certificate registering the freehold ownership of land available to any owner(s) under the Land Transfer Act 1952.

CHARACTERISTIC means any of the physical or chemical characteristics of a trade waste referred to in "New Zealand Standard Model Bylaws Chapter 23 (Int) Trade Waste".

COUNCIL means the Kaikoura District Council ('KDC')

CUSTOMER means a person who either discharges or has obtained a consent to discharge or direct the manner of discharge

of wastewater from any premises to the public sewer of the Kaikoura District Council.

DEED OF COVENANT means an agreement whereby a party stipulates as to the truth of certain facts, or binds any persons to give something to another, or to do or not to do any act.

DISCONNECTION means the physical cutting and sealing of the drain from a premises.

DOMESTIC WASTEWATER means either that wastewater which is discharged from premises used solely for residential activities, or wastes of the same character discharged from other premises, provided that the characteristics of the wastewater and/or stormwater are an acceptable discharge. Such activities shall include the draining of domestic swimming and spa pools subject to 1.6.1.

DRAIN means that section of private drain between the customers' premises and the point of discharge through which wastewater is conveyed from the premises. This section of drain is owned and maintained by the customer (or group of customers).

DRAINAGE DISTRICT means the district or part thereof of the territorial authority for which the Council may provide a drainage system, including, with the consent of the territorial authority, any area within that district.

INFILTRATION means water entering a public sewer or private drain from ground water through defects such as poor joints, and cracks in pipes or manholes. It does not include inflow.

INFLOW means water discharged into a private drain from non-complying connections or other drainlaying faults. It includes stormwater entering through illegal downpipe connections or from low gully traps.

LEVEL OF SERVICE means the measurable performance standards on which the Kaikoura District Council undertakes to receive wastewater from its customers.

MEMORANDUM OF ENCUMBRANCE means an agreement for the payment by any person or persons by yearly or periodical payments or otherwise of any annuity, rent/charge, or sum of money other than a debt where land owned by the person or persons is legally defined and used as security should failure to pay occur.

PERSON includes a corporation sole and also a body of persons whether corporate or incorporate.

POINT OF DISCHARGE means the boundary between the public sewer or public stormwater drain and a private drain.

PREMISES means either:

- (a) A property or allotment which is held under a separate certificate of title or for which a separate certificate of title maybe issued and in respect to which a building consent has been or may be issued, or
- (b) A building that has been defined as an individual unit by a cross-lease, unit title or company lease and for which a certificate of title is available, or
- (c) Land held in public ownership (e.g. reserve) for a particular purpose.

PROHIBITED CHARACTERISTICS means a wastewater which shall not be discharged into the Kaikoura District Council system, as scheduled in "New Zealand Standard Model Bylaws Chapter 23 (Int) Trade Waste".

PUBLICLY NOTIFIED means published on at least one occasion in a newspaper circulating in the Kaikoura District Council wastewater drainage area, or, under emergency conditions, by the most practical means available at that time.

RISING MAIN means a sewer through which wastewater is pumped.

SCHEDULE OF RATES AND CHARGES means the list of items, terms and prices for services associated with the discharge of wastewater as approved by the Kaikoura District Council.

SERVICE OPENING means a manhole, or similar means for gaining access for inspection, cleaning or maintenance, of a public sewer.

SEWER means the main public conduit and lateral connections that carry away wastewater from the point of discharge. The public sewer is owned and maintained by the Kaikoura District Council.

STORMWATER means all surface water run-off resulting from precipitation.

STORMWATER DRAINS means the main public stormwater drain and lateral connections that carry away stormwater from the point of discharge. The public stormwater drain is owned and maintained by the Kaikoura District Council.

TERRITORIAL AUTHORITY (TA) means a city council or a district council.

TRADE PREMISES means any premises used or intended to be used for carrying on any trade or industry, and includes any land or premises wholly or mainly used for agricultural or horticultural purposes.

TRADE WASTE means any liquid, with or without matter in suspension or solution, that is or may be discharged from a trade premises in the course of any trade or industrial process or operation, or in the course of any activity or operation of a like nature, but does not include condensing water, stormwater or domestic wastewater. Condensing or cooling waters, and stormwater which cannot practically be separated from wastewater may be included subject to specific approval.

WASTEWATER means water or other liquid, including waste matter in solution or suspension, discharged from a premises to a sewer.

WASTEWATER AUTHORITY (WWA) means the unit of a territorial authority including its authorized agents, responsible for the collection, treatment and disposal of wastewater.

1.3 Acceptance of discharge

1.3.1 Domestic wastewater

Every domestic premise shall be entitled to have its wastewater accepted by the KDC subject to:

- (a) The premises lying within a "drainage district" if such an area has been designated by the KDC under the Local Government Act 1974 (LGA), and
- (b) The premises lying within an area which is served by public sewers, and
- (c) Payment of the appropriate rates and charges in respect of that premises in general and wastewater services in particular, and
- (d) Fulfillment of the requirements of this bylaw.

1.3.2 Trade waste

The acceptance of trade wastes is not governed by this bylaw.

1.3.3 Stormwater

Unless authorised by Council no person shall:

- (a) Cause, permit or suffer any pollutant, noxious or offensive matter to be discharged to stormwater drains or to any conduit connected to stormwater drains; or
- (b) Cause or permit or suffer any steam, or any other matter (solid or liquid) at a temperature higher than 50°C to be discharged to stormwater drains or to any conduit connected to stormwater drains; or
- (c) Cause, permit or suffer any pollutant, noxious or offensive matter to be stored, transported, handled or used in a way that does not adequately protect against the potential entry of those materials into stormwater drains.

1.4 Approval to connect

1.4.1

No person other than the authorised agents of the KDC, shall without approval, make any connection to or otherwise interfere with any part of the KDC's wastewater or stormwater drainage systems.

1.5 Continuity of discharge

1.5.1

The KDC does not guarantee to receive wastewater without interruption, however the KDC will use all reasonable endeavors to ensure that any disruption is kept to a minimum.

1.6 Premises

1.6.1 Flowrate

The maximum instantaneous flow rate discharged from a domestic premise to the public sewer shall not exceed 2.0 litres/sec. The KDC may also set a maximum daily flow rate discharged from a domestic premise.

1.6.2 Prohibited characteristics

No wastewater with prohibited characteristics shall be discharged into the KDC sewer system.

1.6.3 Waste minimization

In order to meet the principles of sustainable management as promoted by the Resource Management Act 1991 (RMA), the KDC recommends customers fit the devices contained in table 1.1 on all new installations.

Table 1.1 - Waste minimization devices

Device	Value
Insert devices, e.g.: Dual flush toilet cistern	Flush 1 3 litres
	Flush 2 6 litres
Low flow shower heads	Max. 8 litres/min
Urinal flushing control	On-Demand Controller

1.6.4 Access

1.6.4.1 Access for inspection

The customer shall allow the KDC, or its agents, access to and about the point of discharge for the purposes of monitoring, testing, and maintenance work between 7.30 am and 6 pm on any day. The KDC shall give 24 hours previous notice to the customer of the intended entry.

Under emergency conditions, or for the purpose of ascertaining whether the drains are being misused, the customer shall allow the KDC free access to and about the point of discharge at any hour.

1.6.4.2 Non-complying connections

The customer shall allow the KDC with any necessary equipment, access to any area of the premises for the purposes of ascertaining whether non-complying connections have been made.

1.6.5 Prevention of inflow and infiltration

The customer shall prevent any stormwater or groundwater entering the wastewater drainage system. This includes roof downpipes, surface water run-off, overland flow, and sub-surface drainage.

1.7 Disconnection

1.7.1

A customer shall give 7 working days notice in writing of his or her intention to demolish or remove a building connected to the sewer. The demolition or removal shall not commence until the property has been disconnected from the sewer by the KDC.

A customer shall give 2 working days notice in writing to the KDC of his or her requirement for disconnection of the discharge connections if relaying of the private drain is required.

1.8 Public drainage system

1.8.1 General

For the purposes of this clause 1.8, the term 'public sewers' includes Council's stormwater drains. With respect to building or loading over buried services, or excavation near public sewers, the restrictions described in 1.8.2 to 1.8.4 shall apply. Other restrictions may be applied by the KDC for the protection of the public drainage system after consideration of proposed work methods, depth of excavation, soil physical properties, and other site specific factors.

1.8.2 Building over buried services

No building shall be constructed over any public sewer or closer than the greater of:

- a. 1.5 metres from the centre of any such sewer, or
- b. The depth from the surface of the centreline of the sewer, plus the diameter of the sewer plus 0.2 metres from the centre of that sewer subject to compliance with 3.1 of NZS 3604;

Unless such building meets all of the conditions of Kaikoura District Council's Policy for Building Over Services Reticulation.

1.8.3 Loading or material over public sewers

No person shall cause the crushing load imposed on a public sewer to exceed that which would arise from the soil overburden plus a HN-HO-72 wheel or axle load (as defined by Transit New Zealand Bridge Manual).

No person shall place any additional material over or near a public sewer without approval.

Service openings shall not be covered in any way unless approved. Removal of any covering material or adjustment of the opening shall be at the property owner's expense.

1.8.4 Excavation near drains

No person shall excavate, or carry out piling or similar work closer than 5 metres from the centre line of any public sewer or

stormwater drain without approval. Such approval may impose conditions on the carrying out of any work near the sewer or drain.

1.9 Storage of hazardous materials

1.9.1

The occupier shall not store raw material, products or wastes containing corrosive, toxic, biocidal, radioactive, flammable, or explosive materials, or any material which, when mixed with the wastewater or stormwater stream, is likely to generate toxic, flammable, explosive or corrosive materials in quantities likely to be hazardous, or any other material likely to be deleterious to the KDC wastewater or stormwater systems or the health and safety of KDC staff and the public, without taking all reasonable steps to prevent entry into the KDC sewer or stormwater drain from leakage, spillage or other mishap.

1.9.2

The occupier shall comply with the requirements of the Dangerous Goods Act and Regulations.

1.10 Breaches and remedies

1.10.1 Defect notices

In the event of a breach of statutory or other legal requirements, the KDC may serve a defect notice on the customer advising its nature and the steps to be taken within a specified period, to remedy it. If, after the specified period, the customer has not remedied the breach, the KDC may charge a reinspection fee.

If however the breach is such that public health, or safety considerations, or risk of consequential damage to KDC assets is such that delay would create unacceptable results, the KDC may take immediate action to rectify the defect, and recover all reasonable costs as set out in 1.10.2.

1.10.2 Remedial work

At any time after the specified period of 1.10.1 has elapsed, the KDC may carry out any remedial work required in order to make good the breach, and to recover from the person committing the breach all reasonable costs incurred in connection with the remedial work.

POLICY FOR THE DISCHARGE AND ACCEPTANCE OF WASTEWATER

2.1 Introduction

2.1.1

The discharge and acceptance of wastewater is subject to a number of Acts, Regulations, Bylaws, Codes and Standards the most relevant of which are listed below.

(a) Statutory Acts and Regulations

Building Act 1991 [BA]
Building Regulations 1992 (including the New Zealand Building Code) Dangerous Goods Act 1974
Dangerous Goods Regulations 1980 & 1985
Health Act 1956 [HA]
Health and Safety in Employment Act 1992
Land Transfer Act 1952
Local Government Act 1974 [LGA]
Plumbers, Gasfitters and Drainlayers Act 1976
Property Law Act 1952
Rating Powers Act 1988 [RPA]
Resource Management Act 1991 [RMA]
Water Supply Protection Regulations 1961

(b) Codes and Standards

New Zealand Building Code [NZBC]
NZS 9201 Model General Bylaws, Chapter 22(Int): 1 995,
Wastewater Drainage [WDBJ]
NZS 9201, Model General Bylaws, Chapter 23(Int):1 995, Trade
Waste [TWB]
NZS 9201, Model General Bylaws, Chapter 7:1994, Water Supply, Part 2
NZS 4404 1981 Code of Urban Land Subdivision
Kaikoura District (Water Supply) Bylaw 1996

2.2 Domestic wastewater

2.2.1

"Domestic" wastewater is defined in the Bylaw as that discharged from premises used solely for domestic residential activities or wastes of the same character discharged from other premises, provided that the characteristics of the wastewater are an acceptable discharge. Such activities shall include the draining of domestic swimming and spa pools subject to a maximum discharge restriction (refer 2.13.4) and 1.6.1 of the Wastewater Drainage Bylaw.

No domestic wastewaters shall:

- (a) Exceed the substance limits scheduled in "New Zealand Standard Model Bylaws Chapter 23 (Int) Trade Waste".
- (b) Contain the substances prohibited in "New Zealand Standard Model Bylaws Chapter 23 (Int) Trade Waste".

2.2.2

Where part of domestic premises is used as an office or other trade related activity from which no trade waste could be produced and which no other persons apart from those living at those premises use, then it shall be treated as domestic premises. Any trade activity which produces or has the potential to produce a wastewater shall be treated as being from trade premises.

2.3 Acceptance and duration

2.3.1 General

The KDC shall continue to accept wastewater from domestic premises once an approved connection to the public sewer has been made. Disconnection of the sewer, or restriction of the water supply are not options available in the event of non-compliance with the law and/or bylaws by the customer. Refer to 2.15 for remedies which are available.

For the customer's obligations refer to 2.13.

2.3.2 Change of ownership

In the event of domestic premises changing ownership, the new owner shall automatically become the new customer of that premise.

2.4 Application to connect

2.4.1 Application

2.4.1.1 Domestic wastewater

Every application for a wastewater service connection shall be made in writing on the form provided in Schedule C together with the prescribed charges. The applicant shall provide all the details required by the KDC. An application shall be made whether or not a public sewer has already been laid up to the point of discharge.

2.4.1.2 Domestic wastewater and trade waste

Where an application has been accepted by the KDC which requires a new public sewer connection to be constructed from the existing public sewer to the point of discharge, the customer shall pay such charges as fixed by the KDC for this work. The KDC shall supply and install the public sewer up to the point of discharge except as provided for in 2.4.2.

2.4.1.3 Payment of connection charges.

Refer 2.14.

2.4.2 Subdivision

Where a new public sewer is required as part of a subdivisional development, the developer shall provide all the drainage works subject to the approval of the design and construction of the works. These will be covered by Transitional Provisions of the Resource Management Act, or by way of Rules in the District Plan.

2.5 Point of discharge

2.5.1 General

The point of discharge from a customer shall be the point on the public sewer which marks the boundary of responsibility between the customer and the KDC, irrespective of property boundaries.

Unless otherwise approved there shall be one point of discharge only for each premises, and any private drain shall not extend by

pipe or any other means to serve another premises unless it is a common private drain.

2.5.2 Single ownership

For single dwelling units the point of discharge shall be located at the point of physical connection to the public sewer, whether it be within a road, other public lands, or private land.

The approval of more than one point of discharge must be by the KDC and also recorded on the drainage plan.

Location of points of discharge are shown in figure 2.1.

2.5.3 Layout

The typical layout at a point of discharge is shown in figure 2.2.

Figure 2.1 - POINT OF DISCHARGE LOCATION

Figure 2.1 - POINT OF DISCHARGE LOCATION

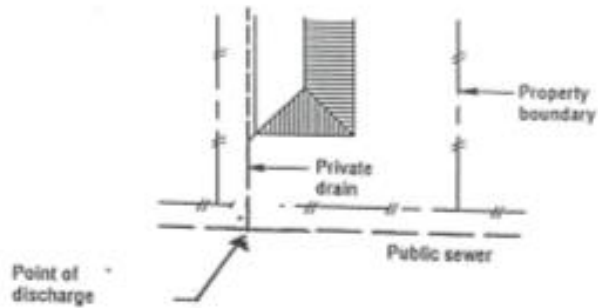

WITH STREET FRONTAGE

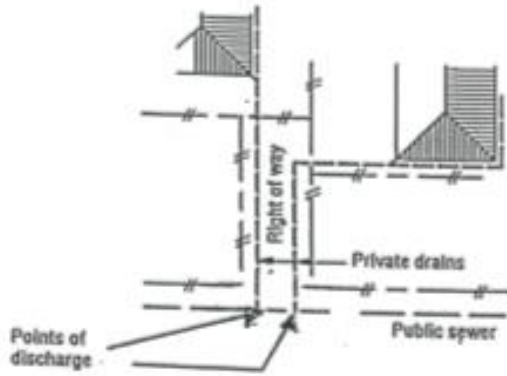

REAR LOTS ON RIGHT OF WAY (up to 2 customers)



REAR LOTS ON RIGHT OF WAY (3 or more customers)

Location of points of discharge

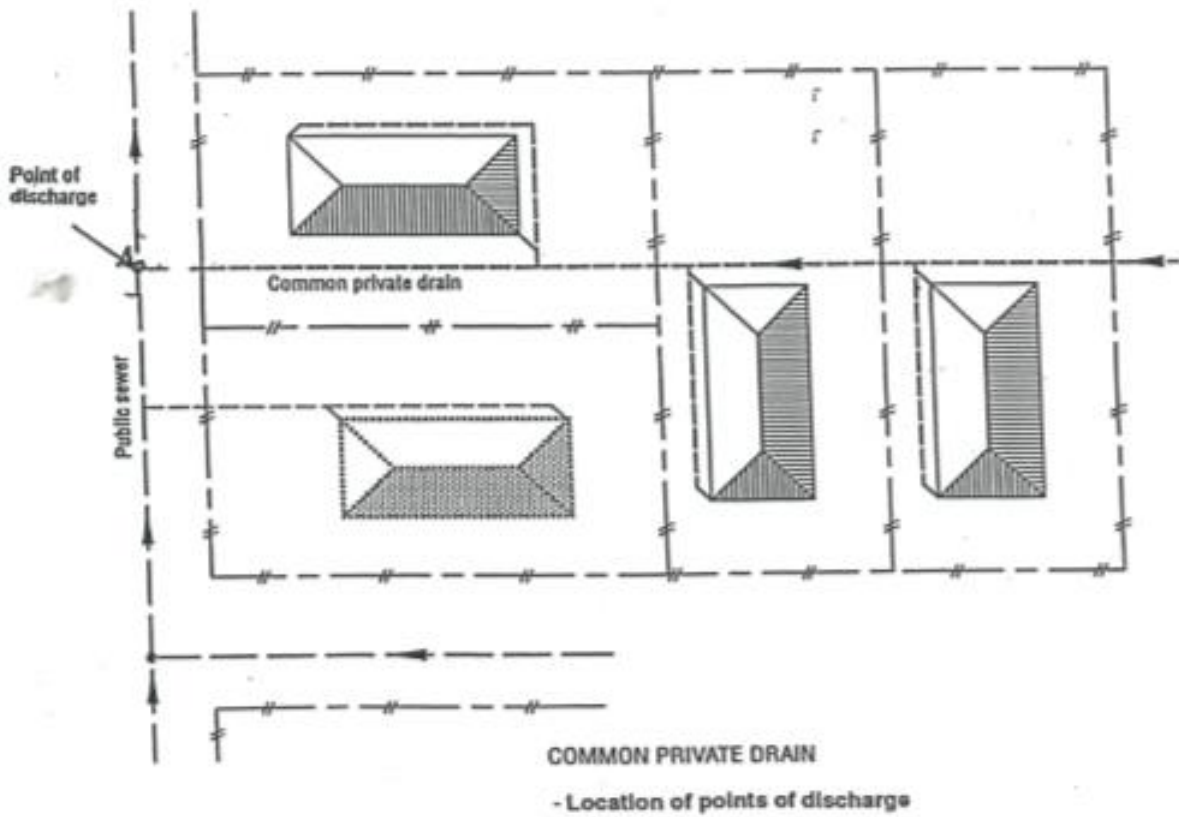
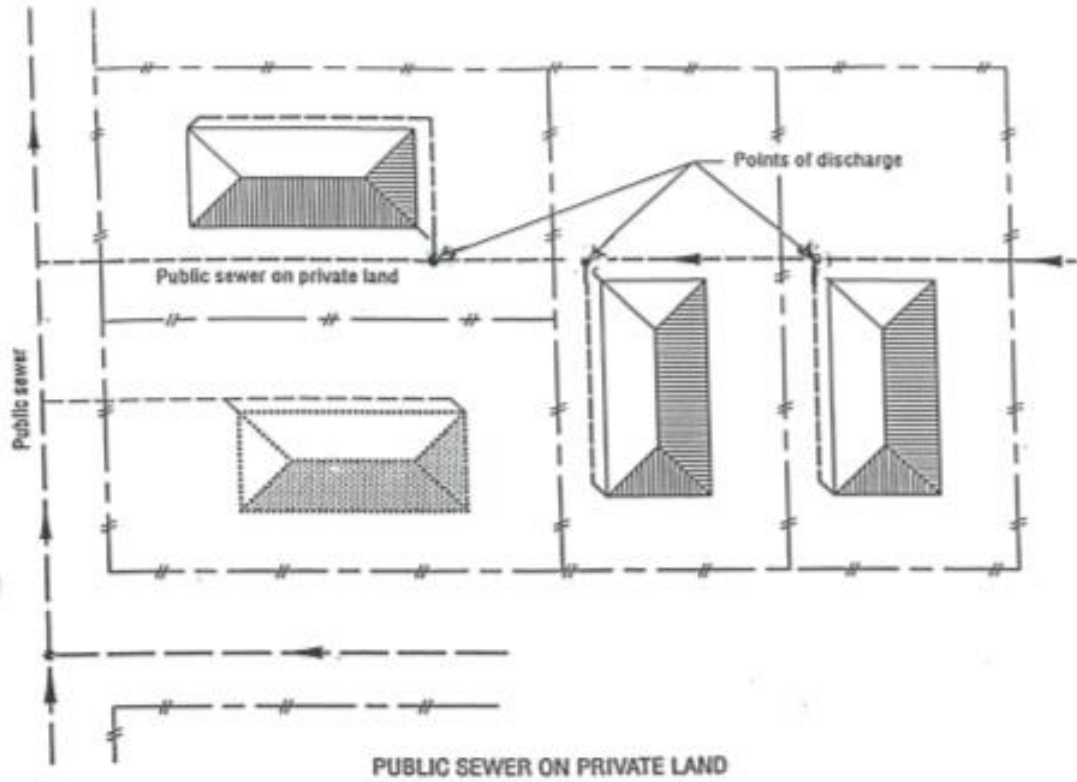
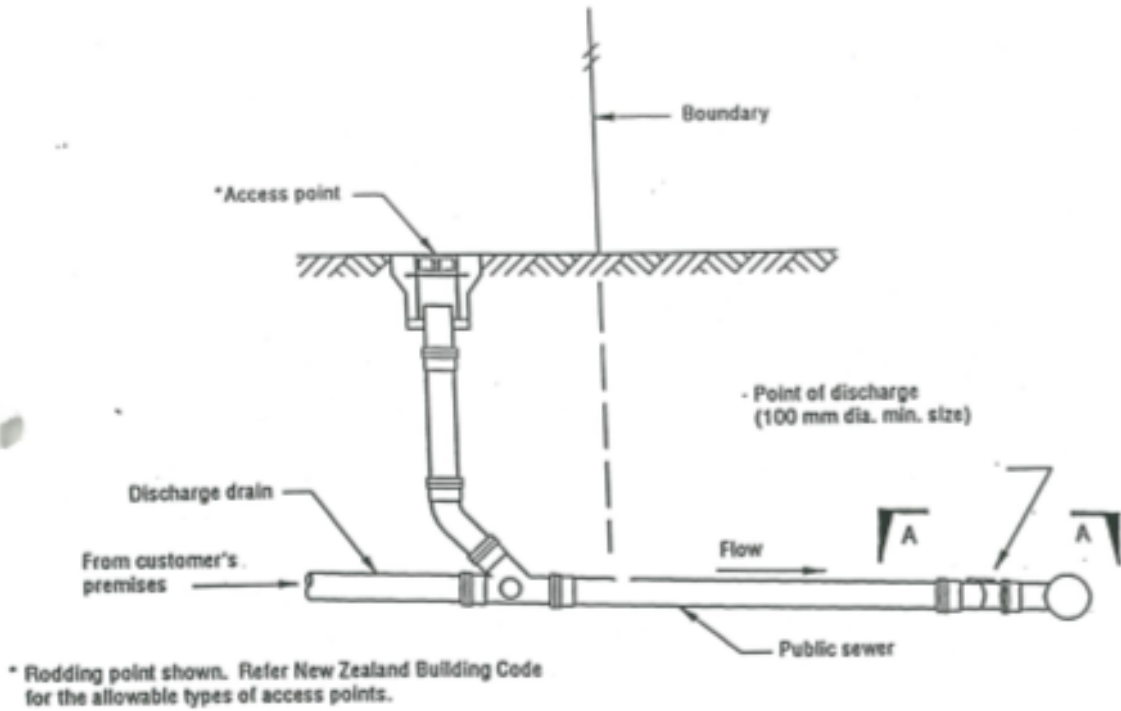
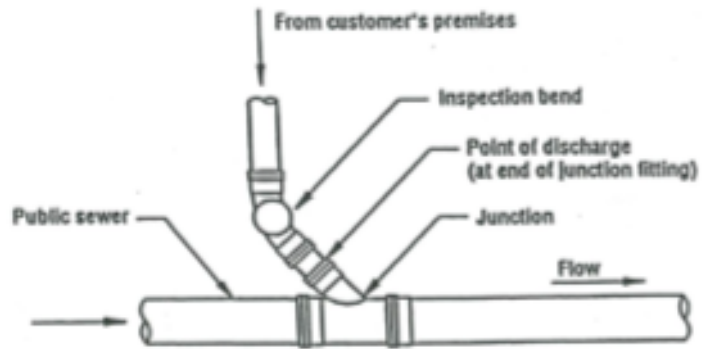

Figure 2.2 - LAYOUT AT POINT OF DISCHARGE



EXAMPLE 1 – DOMESTIC DISCHARGE



PLAN VIEW

EXAMPLE 2 – DOMESTIC DISCHARGE TO PUBLIC SEWER ON PRIVATE LAND and A-A FROM EXAMPLE 1

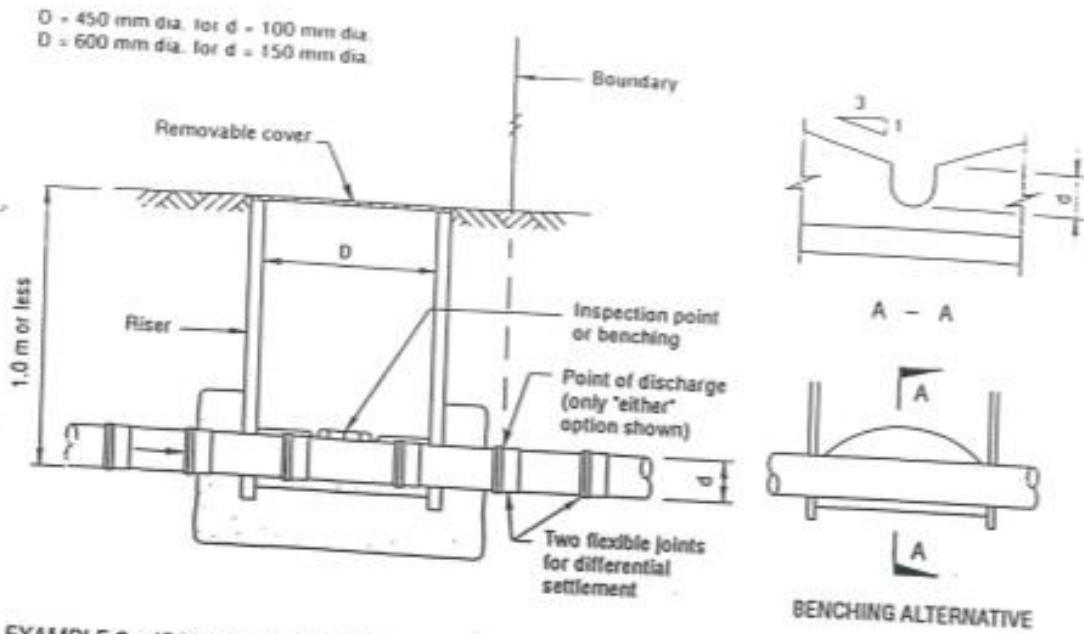

EXAMPLE 3 - 'CONTROLLED' TRADE WASTE DISCHARGES, NOT GREATER THAN 1.0 METRE DEEP

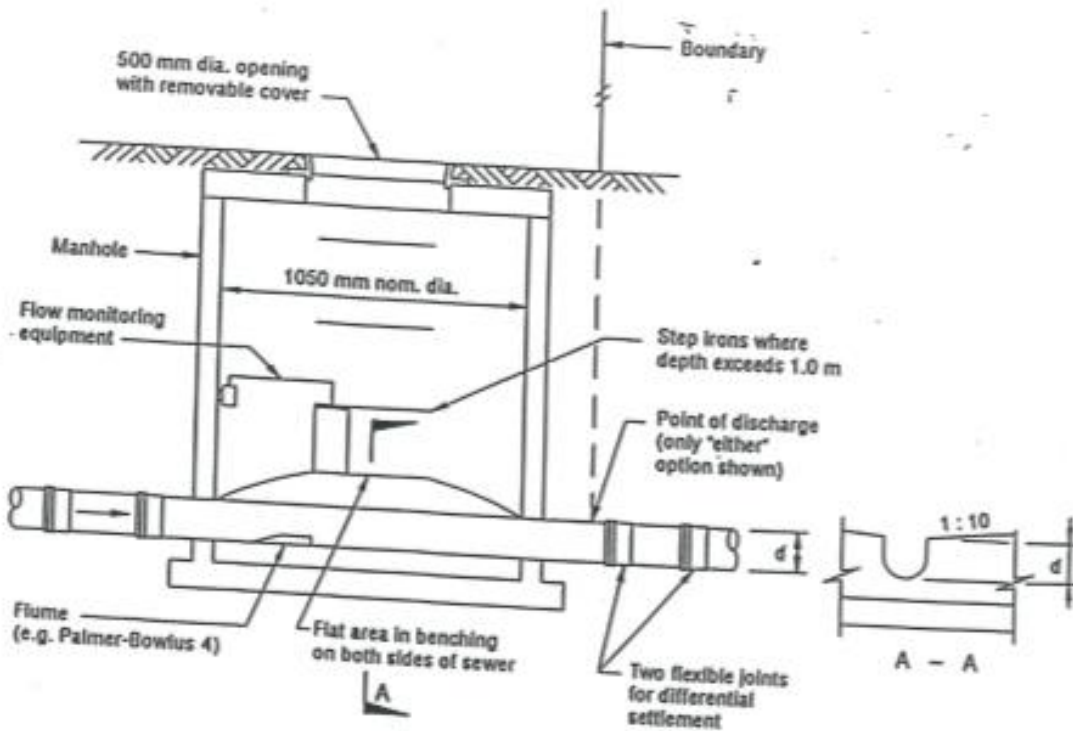

EXAMPLE 4 - OTHER TRADE WASTE DISCHARGES

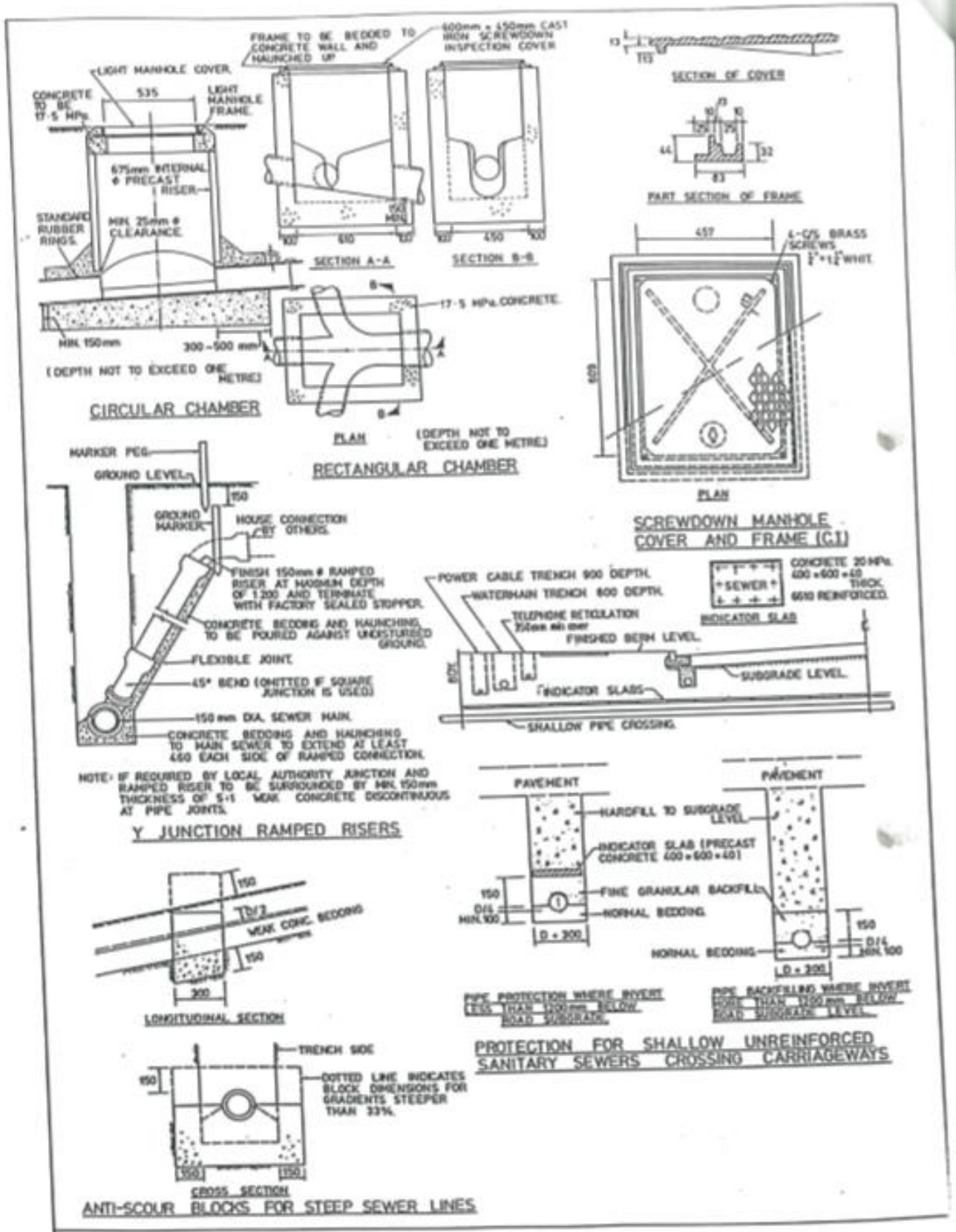

SHALLOW MANHOLES AND SEWER DETAILS

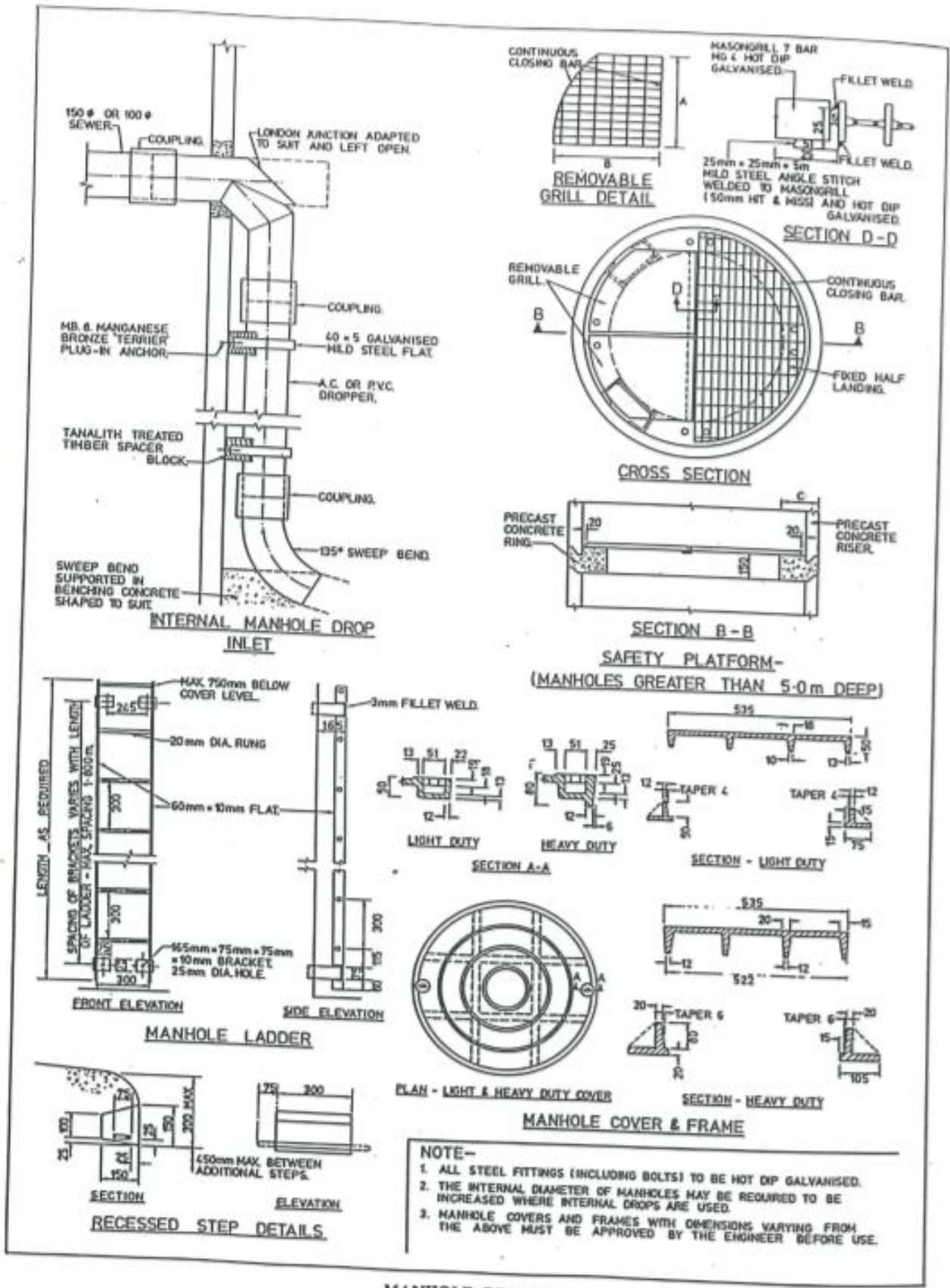

MANHOLE DETAILS

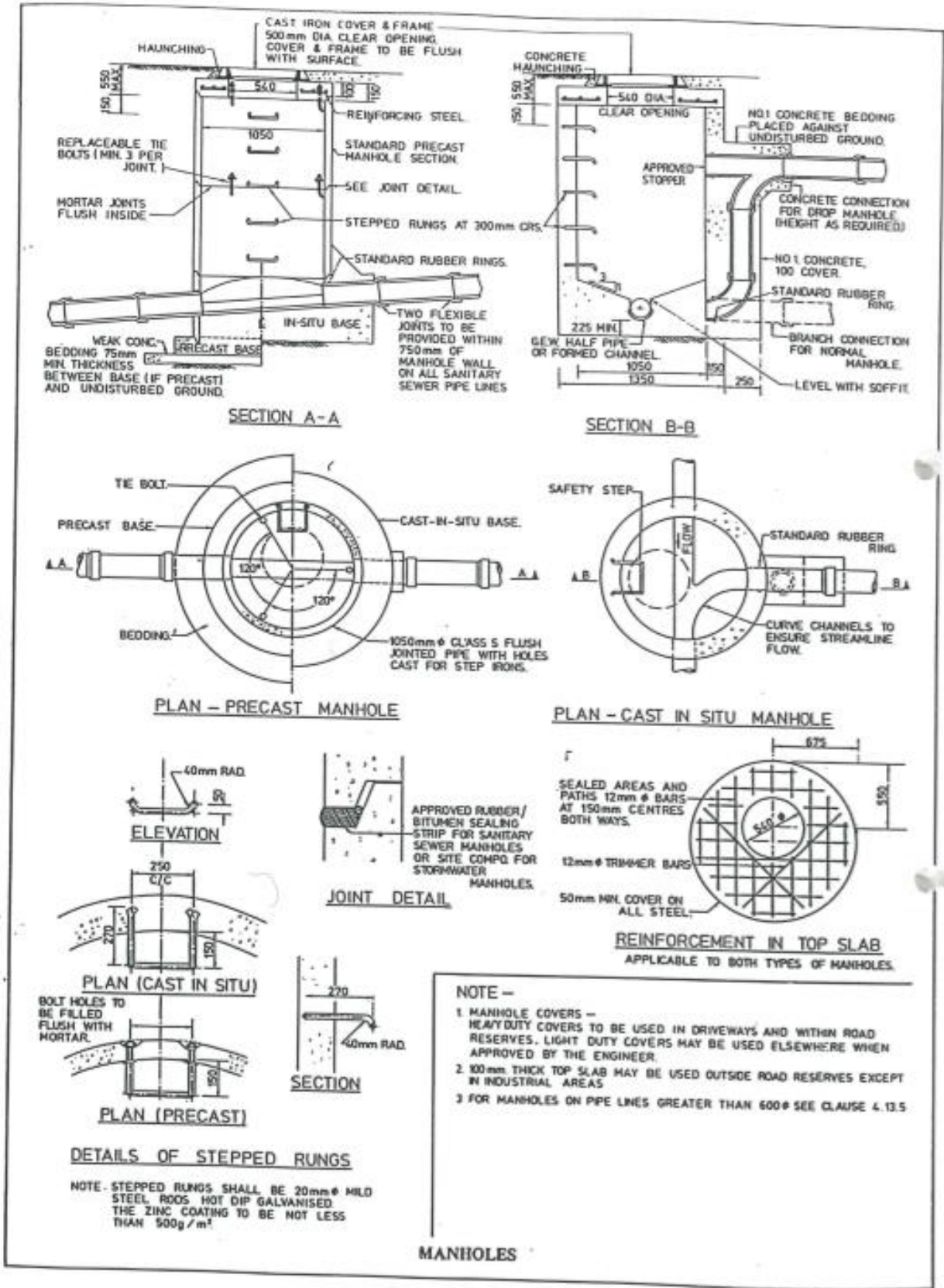

2.5.4 Multiple ownership

2.5.4.1

The point of discharge for the different forms of multiple ownership of premises and/or land shall be as follows:

- (a) For company share/block scheme (body corporate) - as for single ownership-,
- (b) For Leasehold/tenancy in common scheme (cross lease), strata title, and unit title (body corporate). Where practicable each owner shall have an individual drain with the point of discharge determined by agreement with the KDC. If not practicable there shall be a common private drain which shall be incorporated as an additional provision in the lease agreement. In specific cases other arrangements will be acceptable subject to individual approval.

2.5.4.2

Each owner's point of discharge must be approved by the KDC and recorded on the drainage plan. Other arrangements shall be considered only where there are advantages to the KDC.

2.5.4.3

For multiple ownership connections. If no arrangement is recorded then treat as for new connections.

2.5.5 Common private drains

2.5.5.1

Common private drains shall serve a maximum of 7 single dwelling units, providing that the grade of the drain is not less than 1:100 and may also have one point of discharge only (in common).

2.5.5.2

Common drains shall be covered by a certificate from the KDC recording the rights of each party, which is registered against the certificate of title.

2.6 Level of service

The KDC shall provide wastewater services in accordance with the level of service contained in the annual plan of the Council. For those periods where the level of service allows non-compliance with the specified value(s), the KDC will make every reasonable attempt to achieve the specified value(s).

2.7 Liability

The KDC shall endeavor to meet the level of service requirements of 2.6, but it shall not be liable for any loss, damage or inconvenience which the customer (or any person within the premises) may sustain as a result of deficiencies in the wastewater collection system.

DRAFT

2.8 Emergency

2.8.1

Natural hazards (such as floods or earthquakes) or accidents beyond the control of the KDC which result in disruptions to the ability of the KDC to receive wastewater, will be deemed an emergency, and exempted from the levels of service requirements of 2.6.

2.8.2

During an emergency the KDC may restrict or prohibit the discharge of wastewater for any specified purpose, for any specified period, and for any or all of its customers. Such restrictions shall be publicly notified. The decision to make and lift restrictions, and to enact additional penalties, shall be made by the Council, or where immediate action is required the officer of the KDC authorized for that purpose subject to subsequent Council ratification.

2.9 Maintenance and repair

Where it is not practical to notify the customer of a maintenance interruption to the point of discharge before work commences, the KDC may shutdown the point of discharge without notice, and the customer shall be advised as soon as possible.

2.10 Blockages

A customer whose gully trap is overflowing or has other reasons to suspect a blockage, shall first call a drainlayer to clear and remove any blockage in their private drain.

If the drainlayer finds that the blockage is within the public sewer, then the drainlayer shall contact the KDC who shall clear and remove the blockage and clean up all affected areas. Provided that the blockage has not been forced downstream into the public sewer in the act of clearing it from the private drain, or that the customer has not been negligent in discharging non-acceptable wastewater, then the KDC shall reimburse the customer for actual and reasonable drainage costs. If otherwise, the KDC shall recover the costs of the unblocking work from the customer.

2.11 Trees

In the event of the roots of any tree on a Customer's premises causing or being likely to cause damage, interference to the flow, or blockage to a public sewer the KDC procedure shall follow that set out in LGA s.468.

Note that the law does not differentiate between a public sewer on private or public and, i.e. the occupier or owner cuts down or removes the tree at their expense with no compensation payable.

2.12 Working around buried services

2.12.1

The KDC shall keep and maintain drainage plans of the location of its buried services. This information shall be available for inspection during normal business hours at no cost to the user. Reasonable charges may be levied to cover the costs of making copies available.

2.12.2

Any person proposing to carry out excavation work shall view the as-built information to establish whether or not KDC services are located in the vicinity. At least 3 days notice in writing shall be given to the KDC of an intention to excavate in the vicinity of its services. Where appropriate the KDC may mark out to within ± 1.0 m on the ground the location of its services, and may nominate in writing any reasonable restrictions on the work it considers necessary to protect its services.

2.12.3

When excavating and working around buried services due care shall be taken to ensure the services are not damaged, and that bedding and backfill is reinstated in accordance with the appropriate KDC specification. Excavation within roadways is also subject to the permit process of the appropriate roading authority.

2.12.4

Any damage which occurs to a KDC service shall be reported to the KDC immediately. Repair costs may be charged for.

2.13 Customer's drainage system

2.13.1 General

2.13.1.1

The customer's drainage system is governed by the Building Act from inside the building to the point of discharge. The KDC may not impose anything on the customer which is more onerous than is contained in the New Zealand Building Code.

2.13.1.2

The customer's drainage system shall be designed, installed and maintained, both in its component parts and in its entirety, to ensure that it complies with the Building Act and the New Zealand Building Code.

2.13.1.3

Drainage from premises constructed, or for which construction was commenced, prior to the coming into force of the Building Act, does not need to be upgraded to meet the requirements of the New Zealand Building Code. If however any work is required on the customer's drainage system, arising from

- (a) The issuing of a defect notice,
- (b) Alteration to the premises-,
- (c) Change of use of the premises;

then any such work shall meet the requirements of the New Zealand Building Code.

2.13.1.4

Customers with discharges from premises not covered by the Building Act and the New Zealand Building Code shall nevertheless have a drainage system which complies with the Building Act and Code.

2.13.2 Inflow and infiltration

2.13.2.1

Stormwater shall be excluded from the wastewater system by ensuring that:

- (a) There is no direct connection of any stormwater pipe or drain to the wastewater system - unless the wastewater system has been specifically designed as a combined wastewater/stormwater system;

- (b) Gully trap surrounds are set above stormwater ponding levels (refer New Zealand Building Code G13), or secondary overland flow path flood levels;
- (c) Inspection covers are in place and are appropriately sealed.

2.13.2.2

Stormwater which is contaminated may be accepted as a trade waste discharge.

2.13.2.3

For large impervious areas (e.g. stock yards or truck washing facilities), specific provision shall be made for a permanent barrier which will prevent water from outside the confines of the facility from entering the wastewater system. This could be by way of a nib wall, speed humps, or appropriately graded surrounds.

2.13.2.4

Where it is impractical to cover a large impervious area, consideration shall be given to a system which detains run-off from the 'first foul flush' for ultimate disposal to the wastewater system, with subsequent run-off disposal as stormwater.

2.13.2.5

Private drains shall be kept and maintained in a state which is free from cracks and other defects which may allow infiltration.

2.13.3 Pump stations

2.13.3.1 General

Private wastewater pump stations will be approved only where there are no practical alternatives for a gravity flow discharge to the public sewer.

2.13.3.2 Single ownership

A private wastewater pump station for a single dwelling unit represents an alternative solution in terms of the Building Act. As such, the Customer (owner) will be required to demonstrate that the pump station complies with the provisions of the New Zealand Building Code when seeking a consent.

2.13.3.3 Multiple ownership

A private wastewater pump station serving more than one residential dwelling unit requires a compliance schedule as well as an annual building warrant of fitness in order to meet the requirements of the Building Act.

A "Common Pump Station Agreement" shall be required between the parties, including appropriate maintenance of rising mains. It shall be registered against the Certificate of Title of each party.

The combined rate of discharge to the public sewer shall not exceed the rate specified by the KDC.

2.13.4 Swimming pools

Customers with swimming or spa pools shall be required to demonstrate that the pool drain has been fitted with a flow limiting device to ensure the discharge does not exceed the maximum instantaneous flow requirement of 2.0 litres/sec.

2.14 Payment

2.14.1

Payment for the discharge of wastewater and related services shall be in accordance with the KDC schedule of rates and charges.

2.14.2

Because of the procedures involved in setting charges as part of a bylaw, the items included in the schedule of rates and charges, and the terms on which they will be charged shall be made by resolution under the annual plan of the Council. Refer to Schedule D for an example list of payment items and terms.

2.15 Breaches and remedies

2.15.1 Powers

2.15.1.1

Powers to enforce penalties relating to the discharging of wastewater by customers are given to the KDC by a number of acts. The Local Government Act deals specifically with trade wastes. Other relevant pieces of legislation are more indirect in application. The Rating Powers Act allows for action to be taken when rates are unpaid, and payment for discharge can be treated as a rate.

2.15.1.2

The relevant legislation includes:

Local Government Act 1974	Section 493, PartXLIV
Local Government Act 2002	
Rating Powers Act 1988	Part VIII
Health Act 1956	Part 11
Building Act 1991	Part XI

2.15.2 Failure to pay

Any money owing for charges and rates for wastewater services becomes a charge on the land. An example of a Memorandum of Encumbrance and Deed of Covenant is given in Schedule A and Schedule B. The memorandum, once registered, will run with the land, and will bind successive landowners. Further, the memorandum specifically provides that when a person, bound by it, transfers the land, then that person ceases to have any liability or obligations under the memorandum.

CONFIRMATION OF BYLAW

IN WITNESS WHEREOF these presents have been executed the day and year first before written.

SIGNED BY)
in the presence of) **Mayor**

THE COMMON SEAL of)

THE KAIKOURA DISTRICT COUNCIL)

was hereto affixed in the presence of)
Chief Executive

The above resolution was confirmed as a special order at a meeting of the Kaikoura District Council held on ??????

SCHEDULE A

MEMORANDUM OF ENCUMBRANCE FOR SECURING A SUM OF MONEY

..... of
(hereinafter together with his/her successors, assigns and personal representatives called "**the Owner**") being registered as proprietor of an estate in fee simple subject however to such encumbrances, liens and interest as are notified by Memorandum underwritten in that parcel of land containing by admeasurement square metres more or less being Lot Deposited Plan and being all the land comprised and described in Certificate of Title

AND desiring to render the land available for the purpose of securing to and for the benefit of the **KAIKOURA DISTRICT COUNCIL** the rent charge hereinafter mentioned does hereby encumber the land for the benefit of the **COUNCIL** with the annual rent charge of **TEN THOUSAND DOLLARS (\$10,000)** (plus GST) to be raised and paid at the times and in the manner following, that is to say in one (1) annual sum on the 1st day of 202.. and on the 1st day of in every year thereafter **PROVIDED ALWAYS** that if during the twelve (12) months immediately preceding the 1st day ofin any year there shall have been no breach of any of the obligations of the Owner under the Deed, a copy of which is attached hereto, then the annual rent charge payable on such 1st day of shall be reduced to **ONE DOLLAR (\$1.00)** **AND** the Owner covenants that he/she shall at all times perform and observe all the obligations and covenants as set out in the Deed.

AND PROVIDED ALSO that if and whenever the obligations of the Owner under the Deed shall have been duly and wholly complied with or shall by effluxion of time or otherwise become no longer enforceable then this Memorandum of Encumbrance shall be wholly discharged by the **KAIKOURA DISTRICT COUNCIL**.

AND PROVIDED ALWAYS that if and when the saidor the registered proprietor for the time being of the land sells, transfers or transmits their interest in the land or any part thereof, then all liability of the said or the said registered proprietor thereof for the time being shall immediately cease and he/she or they shall be released as from the date of the said sale, transfer or transmission **TO THE INTENT** that the liability under this Memorandum of Encumbrance and Deed is only to run with the registered proprietor for the time being of the said land or part thereof.

AND SUBJECT AS AFORESAID the **KAIKOURA DISTRICT COUNCIL** shall be entitled to all the powers and remedies given to Mortgagees and rent chargees by the Land Transfer Act 1952 and the Property Law Act 1952.

SCHEDULE B

DEED OF COVENANT

THIS DEED made the day of202.....

BETWEEN of
(hereinafter together with his/her successors, assigns and personal representatives called "**the Owner**") of the first part

AND **THE KAIKOURA DISTRICT COUNCIL** (hereinafter with its successors and assigns called "**the Council**") of the second part

WHEREAS

- A** The Owner is the registered proprietor of an estate in fee-simple in the land described in the Schedule hereto ("**the land**") and
- B** A carport has been erected on part of the land and
- C** A stormwater sewer and a foul sewer of the Council runs through the land and partly under the area over which the carport has been erected
- D** The carport's position partly over the said sewers is a contravention of and constitutes a continuing breach of the bylaws of the Council as the Owner does hereby admit and by reason thereof the Council would not ordinarily agree for the carport to remain in its present position but has nevertheless agreed for the carport to remain in consideration of the Owner entering into these premises in manner hereinafter appearing.

NOW THIS DEED WITNESSES that in consideration of the aforesaid premises the Owner hereby agrees with the Council as follows:

- 1 **THE** carport covering the said sewers shall remain in its present position and shall not at any time be covered in. The Owner shall not make any alterations or modifications to the said carport except pursuant to this Deed or in accordance with a permit issued by the Council.
- 2 **EXCEPT** in the case of an emergency (as determined in the sole and absolute discretion of the Council), any work carried out by the Council pursuant to this Deed will be carried out during the normal working hours of employees of the Council.

- 3 **THE** granting of the permission by the Council for the said carport to remain in its position is on the strict condition that all the agreements and provisions hereof on the part of the Owner shall be complied with faithfully in all respects and is without prejudice (in the event of any default by the Owner hereunder) to the right of the Council to exercise all or any of the rights, powers and remedies whether civil or criminal conferred upon the Council by the Council's bylaws or by statute or otherwise.
- 4 **THE** Owner hereby agrees to indemnify the Council from and against all costs (including costs as between Solicitor and client), damages and expenses, claims, actions and proceedings of or against the Council in consequence of or arising out of any breach by the Owner of the agreements and provisions hereof and/or the exercise by the Council of any rights, powers and remedies available under this Deed.
- 5 **IN** addition to clause 4 hereof the Owner accepts that the Council will not be liable for any damage to the said carport arising directly or indirectly from a partial or total collapse of either or both the sewers, and will be responsible for the removal of the carport or parts thereof in the event of any such damage as requested by the Council.
- 6 **ALL** costs (including costs as between solicitor and client) of and incidental to this Deed (including the preparation thereof) and the Memorandum of Encumbrance aforesaid (including the preparation and registration thereof against the Title of the land) shall be borne by the Owner and shall be paid prior to and as a condition of the Council's granting of the permit aforesaid.
- 7 **IT** is hereby acknowledged and declared by the Council that if and when the said or the registered proprietor for the time being sell, transfer or transmit their interest in the land or any part thereof, then all liability of the said or the said registered proprietor thereof for the time being shall immediately cease and he/she or they shall be released as from the date of the said sale, transfer or transmission **TO THE INTENT** that the liability under this Deed of Covenant and Memorandum of Encumbrance made in pursuance thereof is only to run with the Owner for the time being of the said land or part thereof.

SCHEDULE C

APPLICATION FORM FOR DOMESTIC WASTEWATER SERVICE CONNECTION

THE WASTEWATER AUTHORITY OF THE KAIKOURA DISTRICT COUNCIL



APPLICATION FOR DOMESTIC WASTEWATER SERVICE CONNECTION

PLEASE PRINT CLEARLY

(use and attach additional sheets as required)

<p>ADDRESS OF PREMISES:</p> <p>.....</p> <p>.....</p> <p>.....</p>
<p>POSTAL ADDRESS OF OWNER:</p> <p>Name</p> <p>Address:</p> <p>.....</p> <p>.....</p>
<p>ARE THE PREMISES ALREADY CONNECTED TO PUBLIC SEWER?</p> <p><input type="checkbox"/> Yes <input type="checkbox"/> No</p>

<p>CONTACT NAME FOR FURTHER INQUIRIES CONCERNING THIS APPLICATION</p> <p>Name</p> <p>Phone..... Email.....</p> <p>Connection with Development: <i>(eg. owner, builder, drainlayer)</i></p> <p>.....</p>
<p>APPLICATION MADE BY:</p> <p>Name.....</p> <p><input type="checkbox"/> Owner <input type="checkbox"/> Authorized Agent</p> <p>Signed</p> <p>Date</p>
<p>DATE CONNECTION REQUIRED BY:</p> <p>.....</p>

<p>CONNECTIONS REQUIRED:</p> <p>Size No</p> <p>Size No</p> <p><i>(Note: Minimum size 100mm)</i></p>
<p>DESCRIPTION OF DEVELOPMENT</p> <p><i>(eg. house, 3 townhouses on cross lease title, block of flats etc.)</i></p> <p>.....</p> <p>.....</p>
<p>DIAGRAM FOR CONNECTION LOCATION</p> <p>See overleaf</p>
<p>VALUATION NO:</p> <p>.....</p>
<p>LOT NUMBER:</p> <p>.....</p>
<p>DP NUMBER:</p> <p>.....</p>

<p>FOR OFFICE USE ONLY</p> <p>APPLICATION:</p> <p>Received by: Date</p> <p>Evidence of Agents Authority <input type="checkbox"/> sighted</p> <p style="margin-left: 150px;"><input type="checkbox"/> not applicable</p>
<p>Referred to Date</p> <p>Connection <input type="checkbox"/> Approved</p> <p style="margin-left: 150px;"><input type="checkbox"/> Not Approved</p> <p>By Date</p>
<p>PROPERTY LINK IDENTIFICATION NUMBER</p> <p>.....</p>
<p>BUILDING CONSENT NUMBER</p> <p>.....</p>
<p>CONNECTION CHARGES</p> <p>No @ \$ =</p> <p>No @ \$ =</p> <p>Total Fee/Advance Payment _____</p> <p><i>(Delete as appropriate)</i></p>
<p>Cashier Receipt No</p>
<p>File No</p>

DIAGRAM FOR CONNECTION LOCATION

(Show distances from boundaries, driveways)

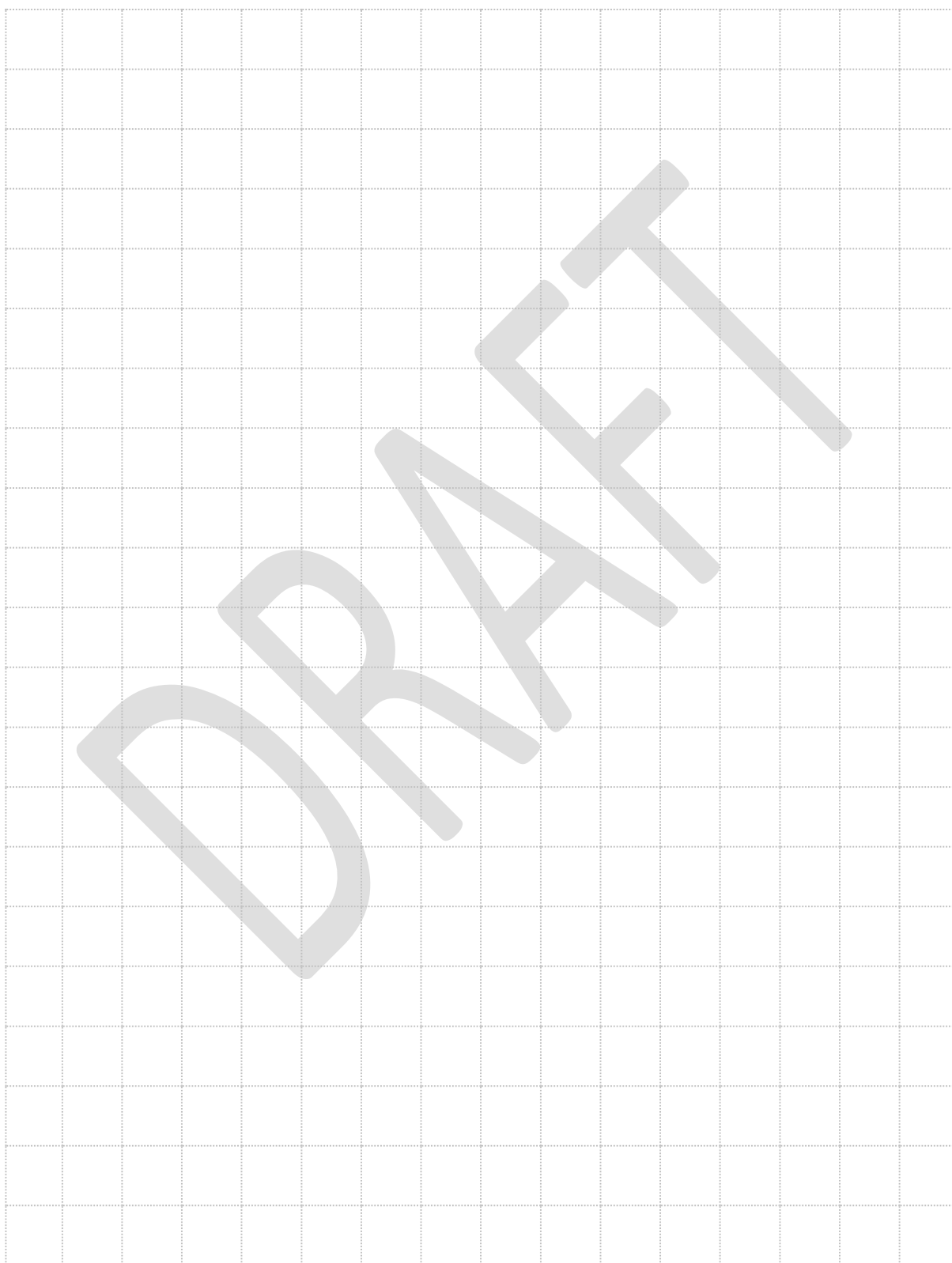

SCHEDULE D

PAYMENT ITEMS AND TERMS - EXAMPLE LIST

Item Terms (guideline only)

Uniform annual (sewer or drainage) charge	A separate charge for wastewater drainage and disposal which is uniform within the KDC area, or for areas within it.
Rates	Wastewater charges included in property rates.
Uniform WC levy ("pan charge")	A uniform levy on each WC or urinal in each premises.
Connection fee	Payable on application for connection to discharge point.
Public sewer fee	Payable where a new public sewer connection is required from the existing public sewer to the point of discharge. Flat fee providing public sewer in street adjacent to property.
Deposit	Additional fee payable on applicable for connection to discharge if required.
Special rates for loan charges	Additional rates for servicing loans raised for the purposes of constructing or improving the KDC wastewater system.
Reinspection fee	A fee payable for each reinspection visit by the KDC where a previously issued default notice has not been remedied by the customer.
Disconnection	A fee payable for disconnection of a discharge connection.

Financial contribution

A payment to be made on connection to the sewer for offsetting the impact of development on the system capacity. Such payments shall be defined in the District Plan of the Council and shall be for the purpose of improving system capacity (reticulation, pumping, treatment).

DRAFT